



PIEZA

TUBO ACERO INOXIDABLE AISI-304 1,2 X 0,1 mm

PART

STAINLESS STEEL TUBE AISI-304 1,2 X 0,1 mm

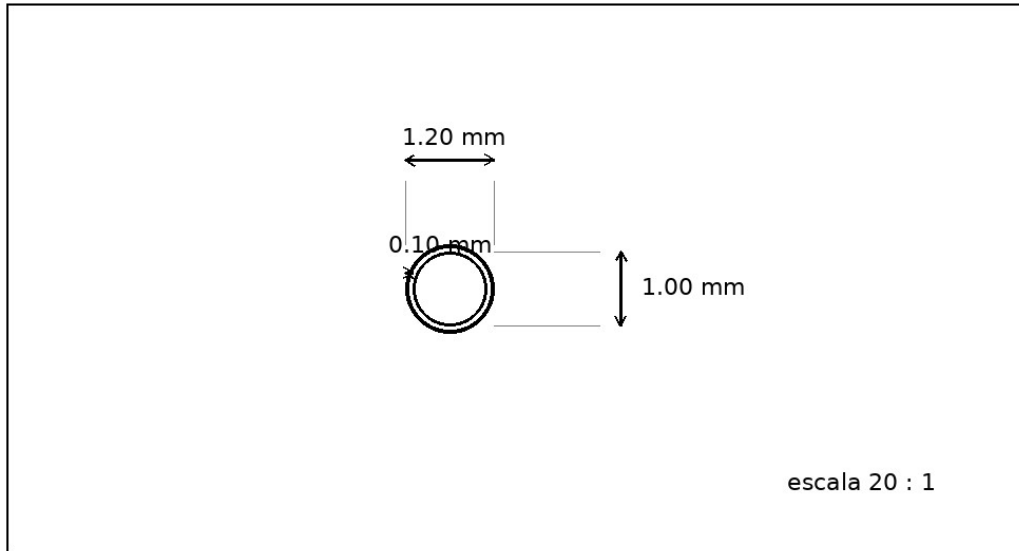

<p>ARTICULO</p> <p>ITEM</p>	<p>TUBO INOX AISI-304 1,2 X 0,1 mm</p> <p>INOX.TUBE AISI-304 1,2 X 0,1 mm</p>	
<p>CARACTERISTICAS TECNICAS</p> <p>TECHNICAL FEATURES</p>	<p>TUBO SOLDADO Y REESTIRADO CALIBRADO EXTERIOR E INTERIOR \varnothing EXTERIOR $1,2 \pm 0,015$ / \varnothing INTERIOR $1,0 \pm 0,015$ mm ACABADO : BRILLANTE TRATAMIENTO : DURO PESO Kg/Mts: 0,0027 PRESION TRABAJO : 125 Kg / Cm2</p> <p>WELDED AND REDRAWN TUBE CALIBRATED EXTERNAL AND INTERNAL \varnothing EXTERNAL $1,2 \pm 0,015$ / \varnothing INTERNAL $1,0 \pm 0,015$ mm FINISHING : BRIGHT TREATMENT : DURO WEIGHT Kg/m: 0,0027 WORK PRESSURE : 125 Kg / Cm2</p>	
<p>OBSERVACIONES</p> <p>REMARKS</p>	<p>SUMINISTROS EN BARRAS DE 1,10 MTS</p> <p>LENGH 1,10 MTS</p>	
<p>PLANO Nº DRAWING Nº</p>	<p>041216-11</p>	<p>A4</p>
<p>REF. TUBO</p>	<p>NEW-0120-100</p>	