

PIEZA  
PART

TUBO ACERO INOXIDABLE AISI-304 4,7 X 0,25 mm

STAINLESS STEEL TUBE AISI-304 4,7 X 0,25 mm

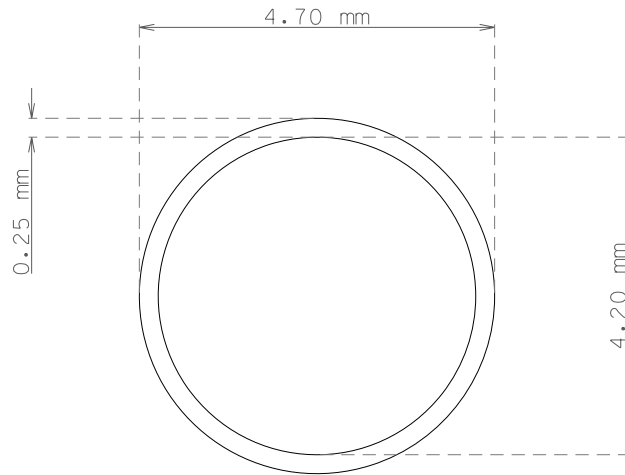

escala 10:1

escala 1:1

<p><b>ARTICULO</b> <b>ITEM</b></p>	<p>TUBO INOX AISI-304 ..... 4,7 X 0,25 mm INOX.TUBE AISI-304 ..... 4,7 X 0,25 mm</p>	
<p><b>CARACTERISTICAS TECNICAS</b>  <b>TECHNICAL FEATURES</b></p>	<p>TUBO SOLDADO Y REESTIRADO CALIBRADO EXTERIOR E INTERIOR  <math>\varnothing</math> EXTERIOR <math>4,7 \pm 0,05</math> / <math>\varnothing</math> INTERIOR <math>4,20 \pm 0,05</math> mm            ACABADO : BRILLANTE            TRATAMIENTO : DURO            PESO Kg/Mts: 0,0280            PRESION TRABAJO : 80 Kg / Cm<sup>2</sup></p> <p>WELDED AND REDRAWN TUBE CALIBRATED EXTERNAL AND INTERNAL  <math>\varnothing</math> EXTERNAL <math>4,7 \pm 0,05</math> / <math>\varnothing</math> INTERNAL <math>4,20 \pm 0,05</math>            FINISHING : BRIGHT            TREATMENT : HARD            WEIGHT Kg/m: 0,0280            WORK PRESSURE : 80 Kg / Cm<sup>2</sup></p>	
<p><b>OBSERVACIONES</b> <b>REMARKS</b></p>	<p>SUMINISTROS EN BARRAS DE 2,00 MTS LENGH 2,00 MTS</p>	
<p><b>PLANO N°</b> <b>DRAWING N°</b></p>	<p>472542-11</p>	<p><b>A4</b></p>
<p><b>REF. TUBO</b></p>	<p>01-0470-025-200011</p>	